

Asterix

Analytical methodology
for chemical screening and
analyses in food surveillance



Asterix

Rapport til Fødevarerforlig 3

1. edition, January 2020

Copyright: National Food Institute, Technical University of Denmark

Photo: Joachim Rode

ISBN: 978-87-93565-64-7

The report is available at

www.food.dtu.dk

National Food Institute

Technical University of Denmark

Kemitorvet, Building 202

DK-2800 Lyngby

Indhold

Introduction.....	3
Asterix – Analytical methodology for chemical screening and analyses in food surveillance	4
1.1 Overall aim	4
1.2 Topic 1: Screenings methods	5
1.3 Topic 2: New analytical strategies	13
1.4 Topic 3: Emerging risk.....	17
1.5 Overall discussion	23
1.6 Overall conclusions	23
1.7 Perspectives.....	23
Dissemination	23
References	24

Introduction

In April 2015 the Danish Parliament adopted Fødevareforlig 3 regarding chemistry in food. Fødevareforlig 3 included research projects on:

- Analytical methodology for chemical screening and analyses in food surveillance,
- Strengthened risk assessment of chemicals, and
- Risk-benefit assessment of foods.

This report is for the Asterix project - Analytical methodology for chemical screening and analyses in food surveillance.

Additional funding obtained from DTU was used for a collaboration on a PhD student project between DTU and ANSES in France, and several external funded projects e.g. the EU project SafeSeaFood. This project has been coordinated with other activities in the work program between DTU and the Ministry for Environment and Food to exploit synergies (in particular NRL and food monitoring).

Persons who have contributed

More or less, all staff in the Analytical Food Chemistry group have contributed together with colleagues from other groups and departments at DTU Food, and various universities. In addition, several students have been attached to the efforts during the 4-year project period.

Principal investigators / theme leaders from DTU

Kit Granby, Katrin Löschner, Henrik Frandsen, Peter Have Rasmussen, Anja Boisen, Jørn Smedsgaard

Post Doc and PhD from DTU

Post. Doc: Manuel Correia, PhD students: Eelco Pieke, Tingting Wang, Shuang Zhai (Demi) and Philipp Eyring,

External collaborators

There have been several external collaborators, most noticeable from those involved in the PhD student's external stay. These are all included in the publications.

Asterix – Analytical methodology for chemical screening and analyses in food surveillance

Through interdisciplinary research, the overall objective has been to develop new comprehensive analytical strategies for food surveillance. The core focus has been to develop and exploit comprehensive screening by accurate mass spectrometry to provide data on highly relevant food safety issues. In parallel, the latest technologies like sensors are surveyed for fast, robust and scalable analytical methods for food monitoring. Finally, emerging risk as nano- and micro-particles are specifically targeted as these cannot be detected by the current methods, hence cannot be included in risk assessment. These goals have been to address through three key challenges in chemical food surveillance:

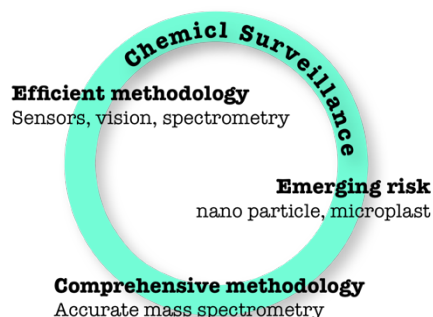

- *The increased complexity and change in chemicals occurring in food call for an even wider scope in analytical procedures.*
- *The analytical methods used for chemical food monitoring are in general complex, expensive and relative slow.*
- *The new emerging risk like nano- and micro-particle avoid the traditional monitoring methodologies.*

Notes

Fødevareforlig 3 was set to start primo 2015, however the formal parliament approval came in late April 2015. Due to the late decision and time needed to recruit staff, the project has been running 6-9 months behind schedule. Moving from the Mørkhøj campus to DTU Lyngby campus in the spring of 2017 also caused some delay in most activities, as the labs were out of operation for about 2-3 months. All have been working hard to make up for the lost time.

The core activities in this project has been done by three fully financed PhD students, one partly financed PhD student, and one partly financed post doc together with senior staff and technicians. The partly financed PhD student finished in January 2018, while two PhD will finish mid-2019, and the last PhD will finish early 2020 (due to maternity leave). Many of the results are not fully processed yet, although nearly all lab work is complete. Therefore, this report contains preliminary results; however, the complete outcome will be published in international journals and in three PhD theses.

1.1 Overall aim

The project mission can be summarized as “*More chemical food monitoring data with less effort*”, underpinning our belief that comprehensive chemical data is critical for trust in food quality. This will contribute significantly to a better risk-benefit assessment for food regulation and recommendation. In summary, the overall deliverables are:

- Provide generic screening method screening for target and untargeted screening of foods, including a quantification strategy and retrospective data mining.
- Explore new analytical technologies to solve specific analytical problems using sensors and micro-fluidics to build a proof of concept set-up.
- Develop analytical strategies to determine the exposure from emerging risks like nano-particles and micro-plastics.

1.2 Topic 1: Screenings methods

The research under the first topic have been exploiting high performance accurate mass spectrometry to develop two critical parts needed for food monitoring by screening. These include a generic sampling and sample preparation strategy for each food commodity and a data processing strategy for interpretation and quantification without availability of standards. The objective has been to get more detailed data from fewer analyses, thereby to identify and quantify a wider range of chemicals in each food sample.

Two PhD students were specifically recruited for this task and began June 1st, 2016 (Tingting Wang and Philipp Eyring). Philipp Eyring has been focusing on generic extraction strategy and automation, while Tingting Wang has been focusing on analytical procedures and data processing. Tingting Wang is on maternity leave from February 2019 to December 2019 and will not complete her PhD project until early 2020. A third PhD student, Eelco Pieke, contributed significantly to the topic and completed his thesis in January 2018. Therefore, this section contains partly finished results and data.

1.2.1 Aim

In general, analytical methods are optimized for specific compounds and only for those with available standards can be quantified, although modern methods can easily detect and separate many hundreds of compounds from complex samples. To address this challenge, the following four objectives were pursued in the topic on the route to a generic screening method:

1. To develop a screening methodology to detect and identify compounds that may migrate into food from contact materials.
2. To develop a screening methodology to simultaneously detect compounds from different chemical classes (e.g. pesticides, mycotoxins, alkaloids) in food commodities.
3. To develop a generic extraction protocol that extract as many compounds as possible
4. To develop a model to estimate the concentration of each compound without needing authentic standards for all compounds using a response model.

The research has been targeting two main food topics: plant material in particular cereals and some of the newer grain-like products (e.g. quinoa) and the food contact material, in particular paper and cardboard. In the first group of products, the target was a wide selection of well-known organic contaminants including pesticides, mycotoxins, natural toxins, and PAH in plant materials; whereas paper and cardboard present a serious analytical challenge with a huge number of compounds where many are unknown.

1.2.2 Activities

Based on high performance accurate mass spectrometry, the following activities have been used to address the challenges in topic 1, divided into linked sub-activities: paper and cardboard, pesticide screening, natural toxins, extraction methodology and semi-quantification.

In the case of paper and cardboard, the focus has been to develop a screening methodology that can detect, preferably identify and also assess the risk of compound that may migrate into food. The core activity has been to develop a generic analytical screening and quantification approach for a worst-case scenario for compounds migrating from paper and cardboard. Based on a rather extensive extraction of contact materials, the extracts were analyzed by an untargeted screening approach to separate, detect, semi-quantify, and tentatively identify a large variety of compounds extracted. This required development of migration test protocol, optimization of analytical conditions for multiple target analysis, and a model to estimate the concentration of many compounds even without access to authentic standards. The latter was in particular challenging, as the identity of many compounds were unknown. An important part of this work was to propose identity of unknown compounds. Thus, the work focused on developing a risk-based approach, where potential identity for unknown compounds were screened for effect using, for example, QSAR. Following a proposed identification of the compounds, a worst-case exposure estimate and risk assessment was done considering the compound identity with highest risk rank (this last part was outside FVF 3 in a collaboration project with ANSES in France). Analysis and quantification of polyfluorinated surfactants in paper and board proved to be daunting due to their bi-polar surfactant nature. Therefore, a rather complex analytical procedure has been developed which includes an in-line SPE purification and a two-column separation. Also, only a very few standards are available to validate methods and as quantification standards.

Implementing screening methodologies for pesticides in cereals and other food was well established from the start of the project due to experience from the multi-target methods that have been used for many years. In this project, the focus was on implementing libraries with accurate mass of other compounds than pesticides to include these compounds in a multiclass analysis. Additionally, usage of multivariate data analysis for the comparison of a larger sets of samples, has preliminary been used to detect of unknown compounds in some samples. The advantage is that unexpected pesticides can be recognized and will allow retrospective data mining in case of suspected occurrences. While the analytical procedure is manageable, data processing is quite demanding and challenges the workflow in these analyses, thus requiring further development.

Occurrence of natural toxins and mycotoxins in plant material is a well-known problem, where two central problems will challenge our analytic protocols: many compounds are not known or not available as standards for quantification, and the occurrence in the food is very irregular ("hot-spot occurrence) due to either growth of fungi or co-harvest of unwanted plants. The activities included two main projects.

A screening method has been developed to include both the regulated mycotoxins and some of the emerging mycotoxins into one method. This activity included a study of occurrence of the group of *Fusarium* toxins called the enniatins in Danish cereals (now published).

The pyrrolizidine alkaloids (PA) occur widely in plants where more than 600 compounds are known. Some of these PA's are considered carcinogenic and due to their wide distribution, are of concern as they can be found in a number of products e.g. honey, tea and herbal tea. The challenge is that the PA group includes many compounds and only a few are available as very expensive standards. Therefore, screening for PA compounds in tea and honey was chosen as a starting platform in order to be able to detect PA's for which standards were not available (Wang T. et al 2018, Eeying P. paper in preparation).

Following these sub-activities, the main effort under this theme has been to develop a generic extraction protocol and a data modelling strategy to estimate concentration without having standards available. The development has been based on a selection of target compounds to cover a realistic wide chemical diversity (approx. 150 pesticides, 20 mycotoxins, 16 PAH and 12 plant metabolites). The food matrices like, cereals, plant material (leaves like tea), and mealworm (a fish feed to represent protein/fat sample type) have been chosen to represent different categories of food. The overall activities are summarized in figure 1 which illustrate the complexity and effort needed on the different parts.

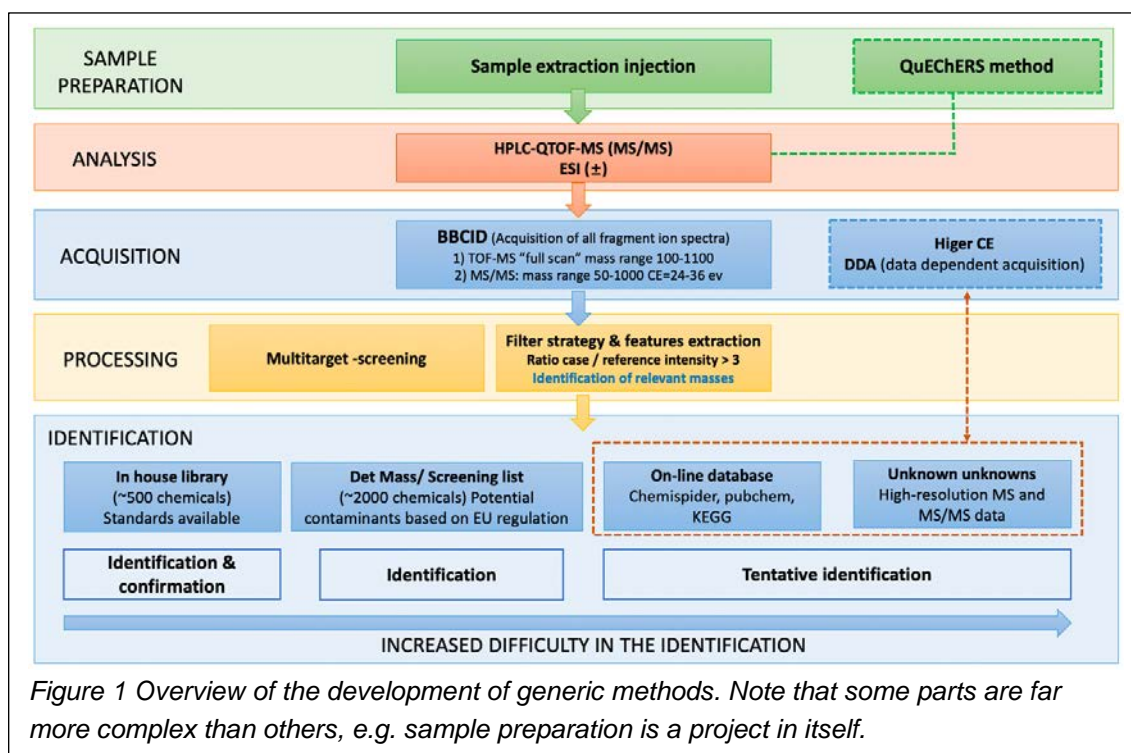
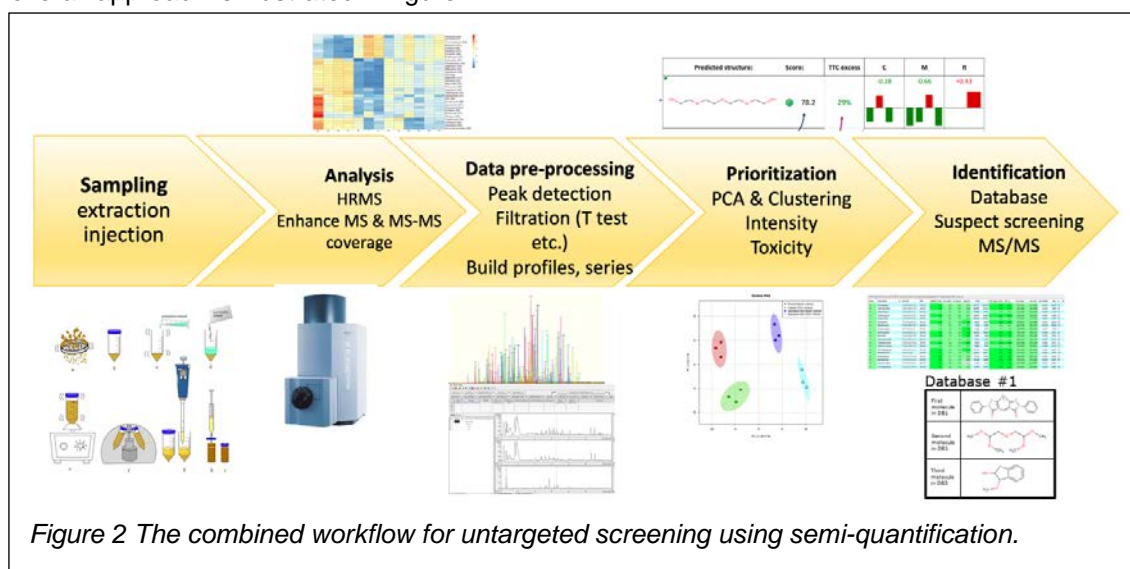

Figure 1 Overview of the development of generic methods. Note that some parts are far more complex than others, e.g. sample preparation is a project in itself.

Development of a generic extraction protocol is based on a modified QuEChERS extraction by including a three-phase extraction. The protocol is now developed and tested for its ability to co-extract a selection of test compounds. About 100 analytes are chosen to represent the chemical diversity within pesticides, PAH's, and mycotoxins from the chosen sample matrices (cereals, corn, plants, feed (mealworms)). The objective is to determine extraction efficiency for each compound and develop a similarity approach to estimate extraction recovery of other compounds, as recovery is critical for quantification of these compounds. As a generic extraction protocol, will by default extract many compounds, the sample clean-up is critical, both

to avoid contamination of instruments but also to reduce sample (matrix) interference that may mask relevant compounds.

Following extraction, the next step is to determine the content (identity) and concentration (quantity) of all compounds in the sample extract. To develop a quantification strategy we have used a wide range of relevant compounds as test examples (approx. 200 pesticides, 20 mycotoxins, 20 natural products, the 16 PAH and a few others) and optimized the analytical conditions for wide scope analysis. A prediction model to estimate the concentration has been developed that use approx. 30 generic marker compounds for quantification. The quantity of all other compounds is estimated using large range of molecular descriptors. The objective is to get quantitative information, even if original standards were not included in the analysis. The overall approach is illustrated in figure 2.



The development of the generic extraction protocol and the tentative quantification model is still work in progress and will be concluded in two PhD thesis mid-2019 and early 2020.

1.2.3 Results

Paper and cardboard

Based on a generic analytical screening and quantification approach, a worst-case scenario was designed to study compounds migrating from paper and cardboard. An extraction protocol using 50% ethanol was used to mimic the worst migration.

First, a screening approach was developed to get a representative profile of extractable compounds. As illustrated in figure 3, optimization of the analytical conditions using a marker test mix, rather than the usual optimization for specific compounds. The marker mix is furthermore used to estimate the concentration.

Secondly, a protocol was established to propose a structure of the compounds, based on accurate mass and physical chemical parameters, followed by an estimation of the concentration from the marker compounds.

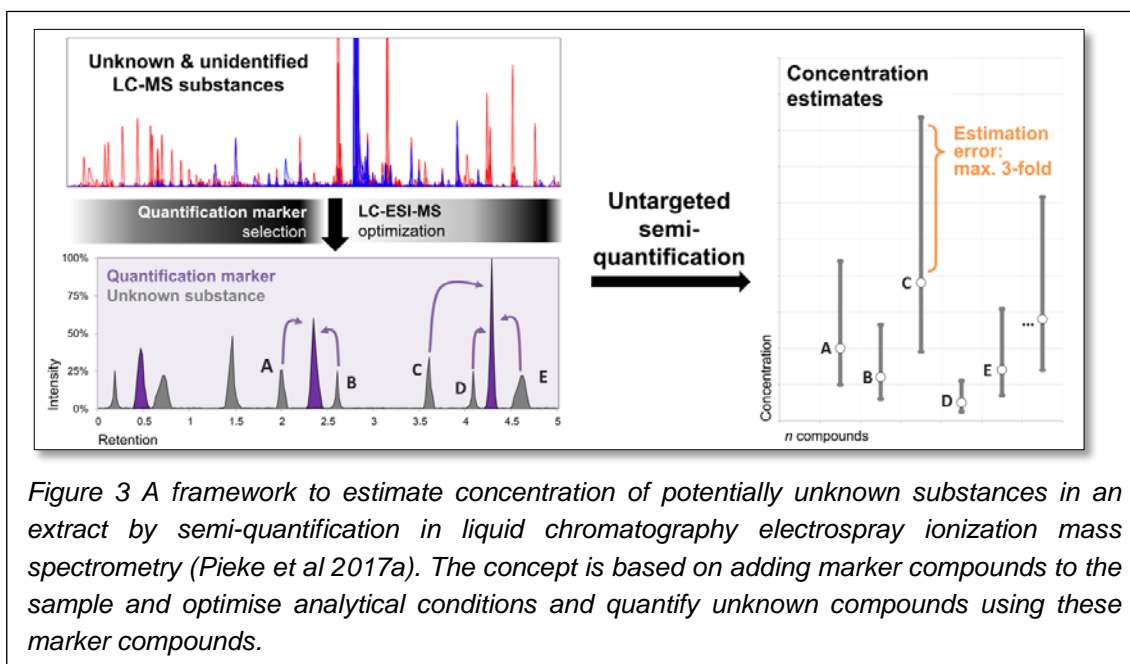

In the final step, all proposed structures were assessed using a range of effect prediction tools including QSAR. Risk estimate risk for identified/quantified compounds were based on the worst-case scenario as illustrated in figure 4 (in collaboration with ANSES).

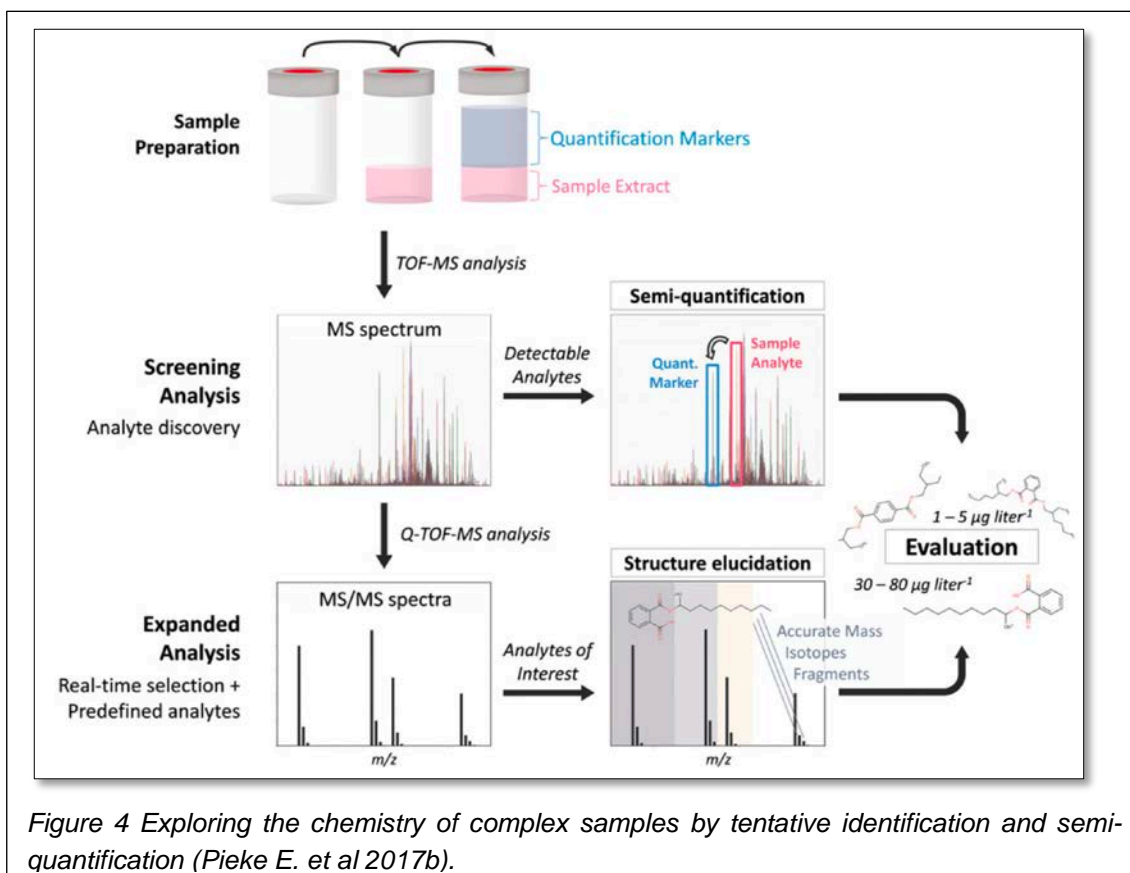

Analysis and quantification of polyfluorinated surfactants in paper and board was particularly daunting due to their bi-polar surfactant, are by nature a rather complex sample, a preparation procedure had to be developed including in-line SPE purification and a two-column HPLC separation.

The result is compiled in Eelco N. Pieke's PhD thesis: "Identification and risk prioritization of unknown contaminants migrating from paper and board food contact materials" defended May 2018 and in four published papers.

Pesticide screening

Screening methodologies for pesticides and other compounds was significantly expanded by implementation and validation of new software for screening of pesticides by accurate high-resolution LC-QTOF-MS allowing to target more than 500 compounds in each analysis. The performance of the pesticide strategy was tested by participation in two screening proficiency tests arranged by the EURL for pesticides (2015, 2016, 2017 and 2018) with positive results. However, while the analytical procedure is manageable, the data processing is quite demanding, therefore the downstream workflow requires further development.

Natural products and mycotoxins

A screening method for mycotoxins resulted in new occurrence data for enniatin A, A1, B, B1 and beauvericin in four Danish crops: oat, wheat, and barley from the 2010 harvest, and rye from 2011 harvest. The occurrence of the four enniatins were B>B1>A1>A. Enniatin B was detected in 100% of the tested samples regardless of crop type. In addition to occurrence data, we reported a proof-of-concept study using a human-relevant high-content hepatotoxicity, or "quadroprobe," assay to screen mycotoxins for their cytotoxic potential. The assay was sensitive for most cytotoxic compounds in the 0.009–100 mM range. Among eight tested mycotoxins (enniatin B, beauvericin, alternariol, deoxynivalenol, aflatoxin B1, andrastin A, citrinin, and penicillic acid), enniatin B and beauvericin showed significant cytotoxicity at a concentration lower than that for aflatoxin B1, which is the archetypal acute hepatotoxic and liver-carcinogenic mycotoxin. The quadroprobe hepato-toxicity assay may therefore become a valuable assessment tool for toxicity assessment of mycotoxins in the future.

A core part of this work has been developing a multi-toxin method that now includes: aflatoxin B2, aflatoxin G1, aflatoxin G2, sterigmatocystine, ochratoxin A, patulin, gliotoxin, deoxynivalenol (DON), nivalenole, 3-acetyl-DON, 15-acetyl-DON, fusarenon-X, HT-2 toxin, T-2 toxin, diacetoxyscirpenol (DAS), DON-3-glycoside, zearalenone, enniatin A, enniatin A1, enniatin B, enniatin B1, citrinin, alternariol, alternariolmonomethyl ether, andrastin, and cyclopiazonic. The method is based on the QuEChERS principle and is in the process of being validated for general use on several different food matrices.

Methods to determine pyrrolizidine alkaloids in honey and tea have been developed and validated in a side project to *Fødevareforlig 3*. The method was extended to include a generic sample preparation followed by analyses with UHPLC connected to high resolution accurate MS. At present the analysis includes 12 different alkaloids. The use of full scan accurate MS makes inclusions of additional compounds easy based upon known retention time and elemental composition. Further as more than 600 PA alkaloids are known, a model to estimate concentration of other PA compounds than those where standard was available have been

developed (Wang T. et al 2018). A significant analytical program with focus on plant relevant compounds is in progress including pesticides, mycotoxins, and natural products – approx. 300 compounds are included and modelled. The objective is to develop more generic quantification methods without authentic standards.

Extraction protocols

Based on the QuEChERS protocol a generic sample preparation protocol has been established as illustrated below. The core idea of extraction samples with acetonitrile have been expanded by changing the salts and the addition of a heptane phase as illustrated in figure 5. Compounds of interest will then be distributed in the three phases. Depending on the sample matrix, the samples can be analyzed directly or will require a simple sample clean-up. The method has been tested on a large range of compounds representing all compounds of interest in food safety and the extraction efficiency (recovery) has been estimated. This is still work in progress and will be completed in June 2019.

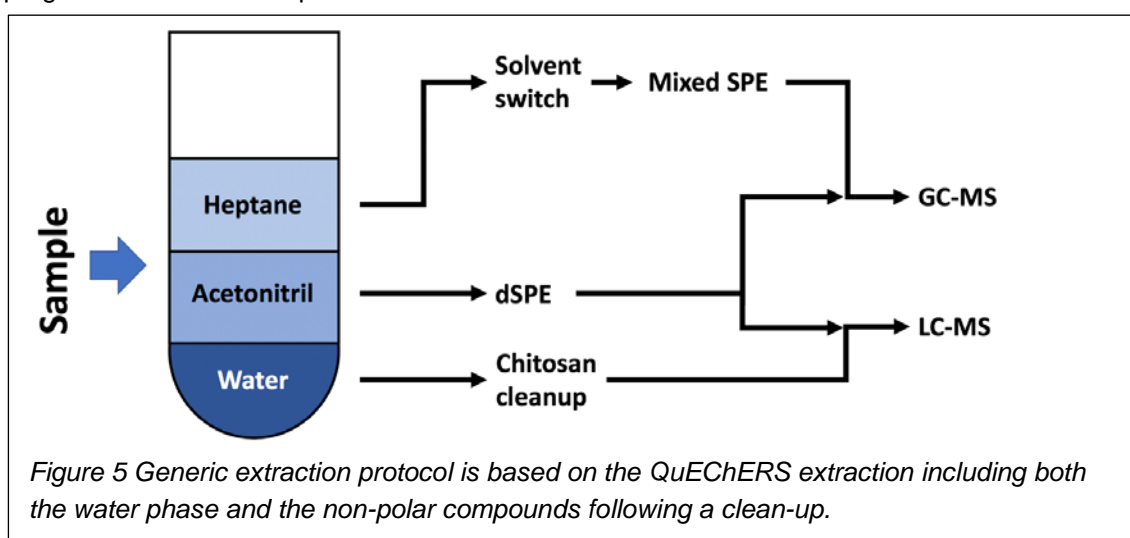

Data processing and quantification

Computer modelling of compound using available software to predict analytical behavior of compound to predict analytical response (critical for quantification). Work on a response model for quantification of compounds in screening analysis when standards have not been included in the analytical series – currently the focus is on quantifying mycotoxins, pyrrolizidine alkaloids, and pesticides using different but chemical similar standards. The work includes modelling the compounds using up to 60 chemical descriptors for each compound combined with multiple variate data modelling. So far, more than 400 compounds are included in the modelling. This work is still in progress and due to maternity leave will be completed in early 2020.

1.2.4 Discussion

The screening techniques started evolving in parallel within the different areas: pesticides, mycotoxins, plant toxins, contaminants, and veterinary drug residues. As the project evolved, the methods developed in each area converged into a common analytic approach where the denominator is the sample matrix rather than the type of compounds. However, we are still left with the challenge that true quantitative analysis require authentic standards both to determine the extraction efficiency and to quantify the compounds. While work is in progress to do

quantitative estimates from instrument data without standards, we still face a challenge regarding the extraction efficiency/recovery. Even so, we may get useable food monitoring data within an error factor of around two or less for a large number of compounds in a single analysis. The use of data and compound modelling can give estimate of concentration that is far better than “no data” for risk assessment although data may not be adequate for food compliance assessment.

The second part is identification of unknown compounds. While very high accuracy (mass accuracy better than 1 ppm) do help a lot, identification of compounds is still a major challenge. However, combined with comprehensive databases, general food chemistry knowledge and knowledge about the sample the number of possibilities can be limited to a rather few possible candidates. Food contact materials are a noticeable exception where the number of unknown compounds and their diversity is huge.

1.2.5 Conclusions

The overall outcome of topic 1 is a far more generic analytical strategy that can change the way we can monitor food for chemical contaminants. However, while not all unwanted compounds can be determined using a screening approach, great many relevant compounds can. What we sacrifice in the analytic accuracy and quantification limit (LOQ), we gain in a much wider analytic coverage. Furthermore, exploiting modern high-resolution accurate mass spectrometry will give comprehensive full spectra data that can be stored and data mined later if new questions arise.

1.3 Topic 2: New analytical strategies

By exploiting the latest technological development in sensors, microfluidics, and vision systems, the idea has been to propose a new technology for rapid specific detection of selected compounds in food. The topic has been a collaboration with DTU Nanotech (IDUN Centre of Excellence) as well as collaboration with a small Danish start-up company. The activities were carried out by a PhD student that is due to finish in June 2019.

1.3.1 Aim

The aim of topic 2 is to propose and design an analytical technology to determine relevant chemical contaminants in a food sample. A number of target problems and technologies were initially evaluated. As basis for practical development of technology, the mycotoxins ochratoxin A (OTA) was chosen as a target compound and for simplicity wine was chosen as the sample matrix.

1.3.2 Activities

The two key challenges were identified early: the problem of sample preparation in case of real food samples, and to get the sensitivity needed. Monitoring OTA in food require a sensitivity down to approximately 1 ppb (thus a LOQ of 1 µg/kg), which was chosen as one of the design criteria. When tested, many detection methodologies were struggling to provide that sensitivity directly from a simple test sample. Therefore, the sensitivity needed to be increased on the sensing technology and/or some kind of sample preparation and concentration technique was to be included in the method.

Several measuring technologies have been assessed: aptamers, antibodies, Raman spectrometry, SERS (surface enhanced Raman spectrometry), fluorescence, and two-photon fluorescence. For sample preparation and concentration, the following techniques were evaluated: support liquid membrane extraction/concentration, microfluidic TLC methodology, and direct paper-based measurement.

Development of a chromatographic separation technique using a centrifugal micro-fluidic system based on TLC plates was initial assed as this system hold the potential to separate complex mixtures and can be directly connected to detection devices. However, when testing the design concept, TLC system was not convincing and difficult to realize.

In collaboration with School of Pharmacy at the University of Oslo, the attention was turned to supported liquid membrane extraction (SLME), see figure 6. The advantage of SLME is that it is easily can be realized using of-the-shelf materials, including 96 well plates and hold the potential for full automation. A simple experimental test-case was selected: determination of OTA in wine as the performance could easily be validated by LCMS and the detailed mechanism monitored by isotopically labeled standards. Several solvents have been tested as liquid membrane, of these, dodecyl acetate is working well allowing detection of OTA directly from spiked wine using an alkaline water phase as acceptor (figure 6). This system provided and efficient concentration factor of approx. 7.5 was obtained which is fairly close to the theoretical contraction factor of 10. And the recovery between 70-110% was reached. At the same time many interfering compounds was removed.

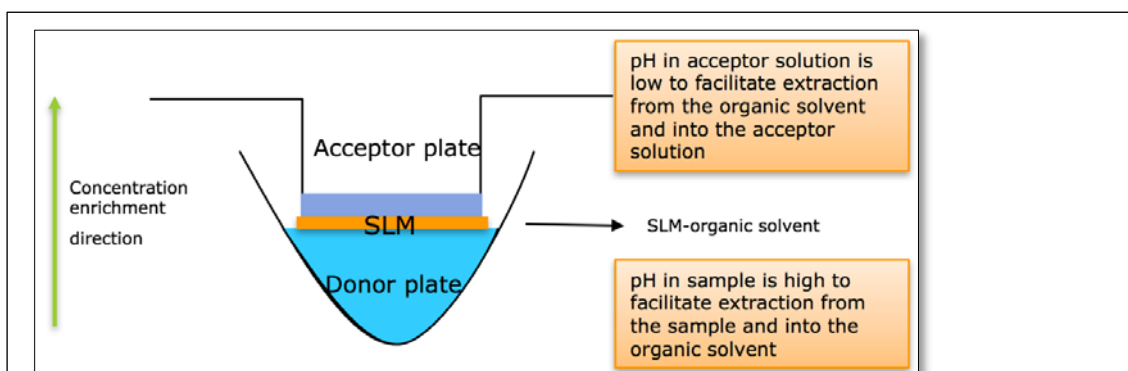

Figure 6 The SLM principle: the donor plate contains the sample (wine) that is brought in direct contact with the membrane with the membrane solvent (dodecyl acetate). On top of the membrane is the acceptor solution (alkaline water). The acceptor solution is analyzed directly. A concentration factor of approx. 7-fold as compared to the wine was reached and many interfering compounds was eliminated.

For detection of compounds three detection principles has been tested: Aptamers, Raman/SERS and fluorescence using classical mass spectrometry as a reference method:

Aptamers are synthetic DNA structures that work like antibodies but can be designed to be very specific. These aptamers are bound to a surface where they are allowed to react with the sample. Following the reaction, the number of bound analytes can be determined by e.g. antibodies with a fluorescence marker or electrochemical. The design considered here was based on binding the aptamers to a paper surface for a read-out using standard ELISA equipment. This should allow a dip-stick like analysis. Unfortunately, it proved difficult to get aptamers with sufficient specificity and it was not possible to get neither the specificity nor the sensitivity needed in food analysis.

Raman and Surface Enhanced Raman Spectrometry (SERS) have been pioneered at DTU Nanotech (now DTU Health Technology), where they have developed a gold plated nano-pillar substrate that significantly enhance the raman signal. These SERS substrates will in general give fairly compounds specific signals from compounds that show fluorescence as do several relevant mycotoxins. The SERS substrate enhance the signal by several orders of magnitude into a relevant sensitivity range. While good sensitivity was observed from measurement of wine spiked with OTA and applied directly on the SERS, it was not sufficient to test on at required LOQ level without an a priori preconcentration step like SLME. Increasing the sensitivity of the SERS measurement and developing an efficient coupling to SLME could unfortunately not be investigated further within this project.

A collaboration with the “B-PHOT” group headed by Prof. Dr. Ir. Heidi Ottevaere at Department Applied Physics and Photonics, Vrije Universiteit Brussel (during the external stay for the PhD student) was initiated to develop a “two-photo” fluorescence spectrometry method for low-level detection of mycotoxins. Measuring fluorescence directly on the acceptor phase in SLME extraction was the most promising procedure as the SLME enrichment improved the sensitivity close to the LOQ required for food control.

1.3.3 Results

Initially a paper-based test using aptamers where compounds were detected using antibodies with fluorescent labels was seen promising. While the technique works in specific cases and has been demonstrated for antibiotics in milk, it was not pursued further at this time due to lack of specific aptamers for relevant target compounds. Also, the stacked detection using labelled antibodies increased the complexity and made the detection complex.

Most promising was sample concentration by SLME as illustrated in figure 6 using a dodecyl acetate liquid membrane. The SLME procedure produced an efficient concentration factor of approx. 7.5 from the wine samples which is fairly close to the theoretical contraction factor of 10 and is within the general required recovery requirement for extractions. As the SLME extraction utilized the alkaloid properties of OTA by extracting it into an alkaline acceptor solution, thereby many interfering compounds are removed from the wine e.g. the phenolic compounds. The acceptor solution could be analyzed directly by LCMS without any further sample clean-up.

This work is still in progress and is expected to be completed within the next few months and included in the PhD theses. The last part is to perform measurement using fluorescence directly on the acceptor solution for a proof of concept study. The preliminary result from the two-photo measurement done in Belgium indicates that the required sensitivity should be obtainable (see figure 7). The advantage of direct fluorescence measurement is that it will rather easy to develop into a simple practical solution.

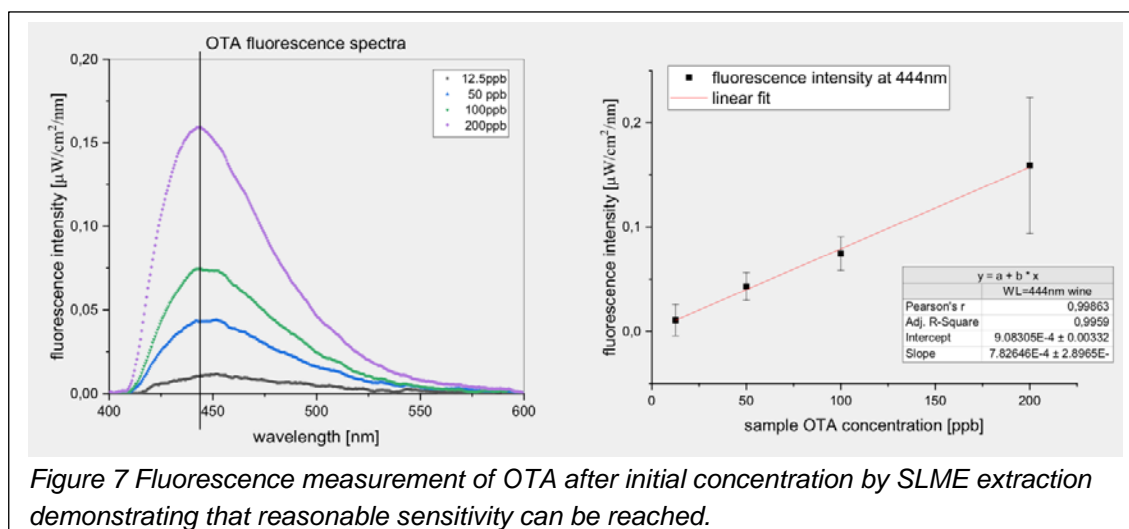

Figure 7 Fluorescence measurement of OTA after initial concentration by SLME extraction demonstrating that reasonable sensitivity can be reached.

1.3.4 Discussion

In general, many techniques and approaches were considered in the first phase of the project. The key challenge has been to get a food relevant sensitivity. The groups that develop sensors always start out with very high concentration levels (ppm range) and using very simple liquid samples. However, bringing these technologies to real food samples at relevant levels (ppb range) proved quite daunting.

The project has focused on establishing an analytical principle, then test the analytical principle followed by a scale down and finally to automate. It was early clear that aptamers, although a

very promising technology based on literature, was challenging to implement due to availability of specific aptamers. After a few initial trials this approach was not pursued further.

Techniques based on spectrometry have many advantages as these technologies are scalable, robust and can be made quite small. However, in the real food world, some sample preparation is nearly always needed to cope with the diversity of food samples.

1.3.5 Conclusions

While the project didn't succeed to provide a complete solution, the evaluation of many technologies revealed a significant potential but require combination of technologies from different domains. Fluorescence, may be combined with other spectrometric techniques (e.g. Near Infrared spectrometry (NIR) and Raman) in an integrated sensor may be one of the solutions or design of very compound specific sensors. Either way, a sample pretreatment will most likely be needed to reach a relevant sensitivity. Finally, a practical conclusion is that a larger technical effort is needed in a project like this, as it requires competences from several fields: electronics, micro-fabrication, analytical chemistry, food science, and computer science.

1.4 Topic 3: Emerging risk

PI: Senior researcher Katrin Löschner and associate professor Kit Granby with post doc Manuel Correia

Microplastic and nanoparticles are increasingly entering the food chain from multiple sources being technological use, as contaminants from the environment and food production/processing or migrating from food contact materials. Today, we don't have general methodologies to monitor their occurrence in food; hence we cannot estimate the human exposure to different kinds of particles. Also, health implications of ingestion of these particles are largely unknown, where health effects may be attributed to both the particles themselves and chemically adsorbed onto the particles. The goal is to provide relevant monitoring methodologies as well as knowledge of the health implication.

1.4.1 Aim

Microplastic and nanoparticles are increasingly entering the food chain from multiple sources being technological use, as contaminants from the environment and food production/processing or migrating from food contact materials. Today, we don't have general methodologies to monitor their occurrence in food; hence we cannot estimate the human exposure to different kinds of particles. Also, health implications of ingestion of these particles are largely unknown, where health effects may be attributed to both the particles themselves and chemically adsorbed onto the particles. The goal is to provide relevant monitoring methodologies as well as knowledge of the health implication.

1.4.2 Activities

Nanoparticles

Analytical techniques for detecting and characterizing metal and metal oxide nanoparticles in food matrices were tested and optimized. The focus was on techniques that could be easily implemented in (control) laboratories that typically perform metal analyses in food. Metal analyses are usually performed by inductively coupled plasma-mass spectrometry (ICP-MS). One promising technique for nanoparticle detection is inductively coupled plasma mass spectrometry in single particle mode (also called "single particle ICP-MS / spICP-MS"). This technique was optimized and tested for several nanoparticle-food matrix combinations. In addition, asymmetric flow field-flow fractionation as a separation technique coupled to inductively coupled plasma mass spectrometry for characterization of nanoparticle mixtures and nanoparticles in food was tested. The results of the work were published in scientific papers and presented at scientific conferences. Additionally, our experiences were shared with the Joint Research Center (JRC), the European Commission's science and knowledge service, during a symposium in May 2017 and within an expert group focusing on titanium dioxide (food additive E171) analysis by single particle ICP-MS in food. This work is part of an activity of the Joint Research Center to prepare the Member State control laboratories in charge of the enforcement of the legislative framework related to nanomaterials in food. Further, we performed a one-day introduction to single particle ICP-MS for the FVST laboratory in Århus end of 2018.

Micro plastics

To study the effect of micro-plastic ingested by fish a model study was conducted in collaboration with DTU Aqua under the EU project ECSafeSeaFood. In these trials' salmon (cold water fish) and sea bass (warm water fish) were raised in the presence of micro-plastic particles together with persistent pollutants in their feed, which significantly influenced the toxicokinetics for some of the contaminants.

1.4.3 Results and discussion

Nanoparticles

In collaboration with the EU FP7 project *NanoDefine*, a method was developed for detection and characterization of aluminum oxide and titanium dioxide in toothpaste. Titanium dioxide is used as white pigment and is permitted as food additive (E171). Aluminum oxide is used as an abrasive particle in the toothpaste. Aluminum is found in several permitted food additives and is therefore relevant in relation to food as well. The method allowed to separate and detect the particles in the toothpaste and to retrieve a correct particle size distribution for titanium dioxide. The potential presence of aluminum oxide particles in the lower size range had a strong impact on sizing and nanomaterial classification upon conversion. This work was published Open Access as: Correia, M., Uusimäki, T., Philippe, A., & Loeschner, K. (2018). Challenges in Determining the Size Distribution of Nanoparticles in Consumer Products by Asymmetric Flow Field-Flow Fractionation Coupled to Inductively Coupled Plasma-Mass Spectrometry: The Example of Al₂O₃, TiO₂, and SiO₂ Nanoparticles in Toothpaste. *Separations*, 5(4), 56.

A method for detection and characterization of silicon dioxide particles (food additive E551) in powdered tomato soup was developed by University of Vienna within the EU project *NanoDefine*. The method was tested by DTU and University of Vienna for other powdered foods, including pancake powder, coffee creamer, and spice mix. However due to severe challenge transferring the method to the other food matrices, it was decided to stop the activities after several months of intensive work. This experience showed how matrix-specific the methods for nanoparticles currently are and how difficult it is to develop generic methods.

Inductively coupled plasma mass spectrometry in single particle mode was tested and improved for several cases:

- 1) We used single particle ICP-MS to investigate (in collaboration with the Swedish National Food Agency) if bullet-shot game contains lead nanoparticles. Lead nanoparticles were detected close to the wound side. Based on the work, a scientific paper was published in the journal "Analytical and Bioanalytical Chemistry" in December 2016 (Kollander, B.; Widemo, F.; Ågren, E.; Larsen, E. H.; Loeschner, K. *Anal. Bioanal. Chem.* 2017, 409, 1877–1885). The results were further presented (as a talk) at the 8th International Symposium on Recent Advances in Food Analysis (RAFA 2017) in November 2017 in Prague.

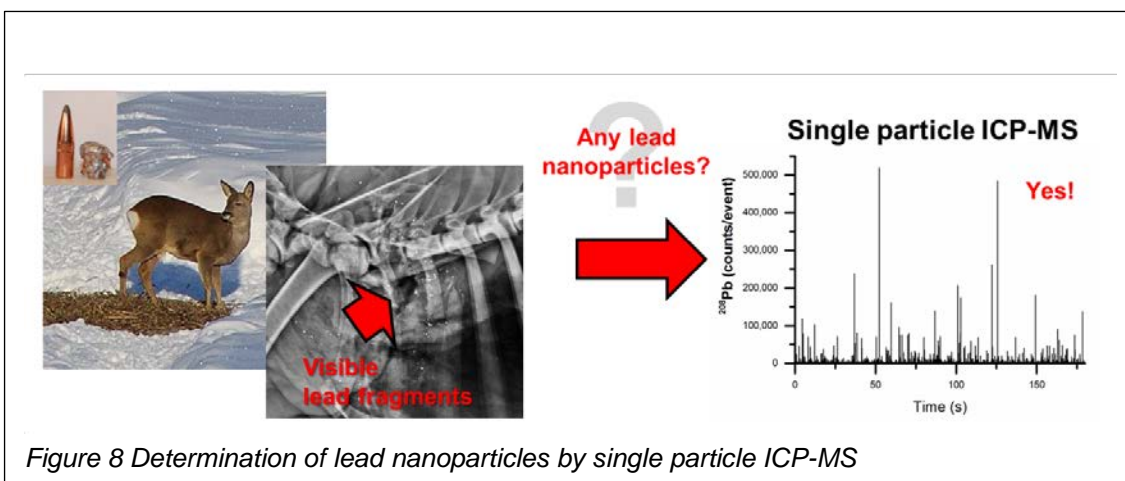

Figure 8 Determination of lead nanoparticles by single particle ICP-MS

- 2) We used single particle ICP-MS to detect aluminum-containing particles in Chinese noodles. The aluminum concentrations in the noodle samples, determined by conventional ICP-MS without or with the use of hydrofluoric acid for digestion, were $5.4 \pm 1.9 \mu\text{g/g}$ and $10.1 \pm 2.2 \mu\text{g/g}$ ($N = 21$), respectively. Aluminum-containing nanoparticles were detected in all 21 samples. Depending on the assumed particle composition, Al_2O_3 or $\text{Al}_2\text{O}_3 \cdot 2\text{SiO}_2 \cdot 2\text{H}_2\text{O}$, the median particle diameters were either below or above 100 nm, respectively. The minimum detectable particle diameter by spICP-MS was between 54 and 83 nm. The mass recovery of aluminum in the form of particles was between 5% and 18%. The A scientific paper with the title “Detection and characterization of aluminum-containing nanoparticles in Chinese noodles by single particle ICP-M” was published in the international journal “Food Additives and Contaminants” in October 2017 (Loeschner, K.; Correia, M.; López Chaves, C.; Rokkjær, I.; Sloth, J. J., Food Addit. Contam. Part A 2017, 35(1), 86–93).
- 3) We used single particle ICP-MS to analyze titanium dioxide nanoparticles in chewing gum, chocolate candy and cake frosting. Further, we spiked reference titanium dioxide particles to milk as an example of a calcium-rich matrix (for which case it is usually more difficult to detect titanium). The obtained sizes were comparable with electron microscopy results. Repeatable determination of number-based particle size distributions was possible. The median particle diameters were in the range of 130 to 200 nm. The results were presented at the European Winter Conference on Plasma Spectrochemistry, 3 – 8 February 2019, Pau, France.
- 4) We further used single particle ICP-MS to study the behavior of ionic silver and silver nanoparticles in food simulants. The work contributed to a better understanding whether classical migration studies (which are used for molecules) for food contact materials can directly be applied for all types of nanomaterials or not. The work was performed in collaboration with the H.C. Ørsted Postdoc Maryam Jokar. The results of the study were published in February 2018 in the international journal “Food Control” (Jokar, M.; Correia, M.; Loeschner, K. Food Control 2018, 89, 77-85.) The major findings were that silver nanoparticles dissolve in all food simulants but to a lesser extent in ethanolic simulants. The formation of silver nanoparticles from silver ions was shown to be unlikely at the typical migration levels (it has been postulated by others that the finding of silver nanoparticles in

migration solutions from food contact materials could be explained with the migration of silver ions followed by reduction and formation of nanoparticles). In connection with this work, a review paper regarding six open questions (“Q1 to Q6”) about the migration of engineered nano-objects from polymer-based food-contact materials was published in the international journal “Food Additives and Contaminants: Part A” in December 2016 (Jokar, M.; Pedersen, G. A.; Loeschner, K. Food Addit. Contam. Part A 2017, 34 (3), 434–450):

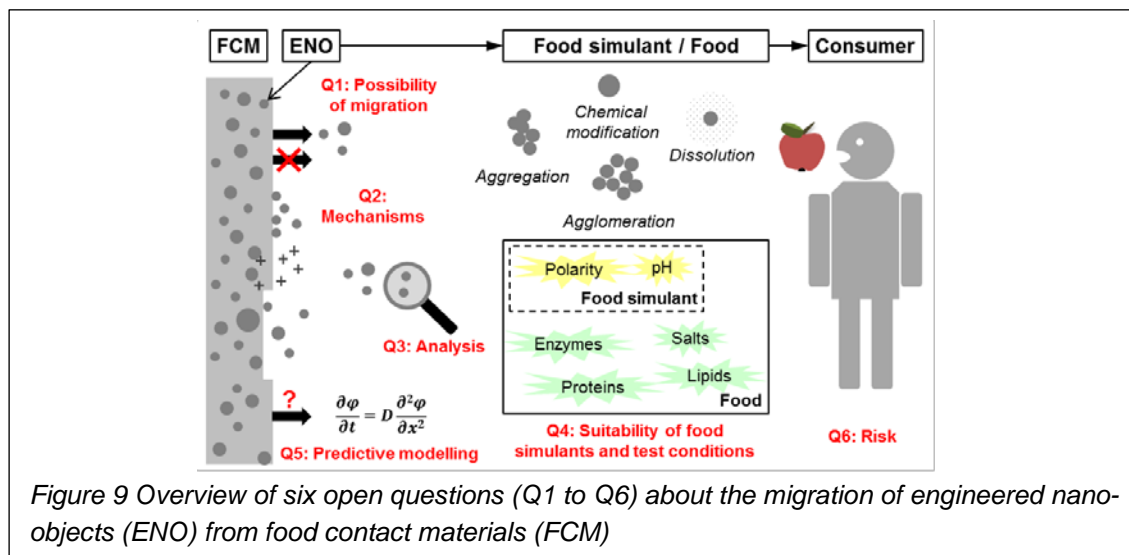
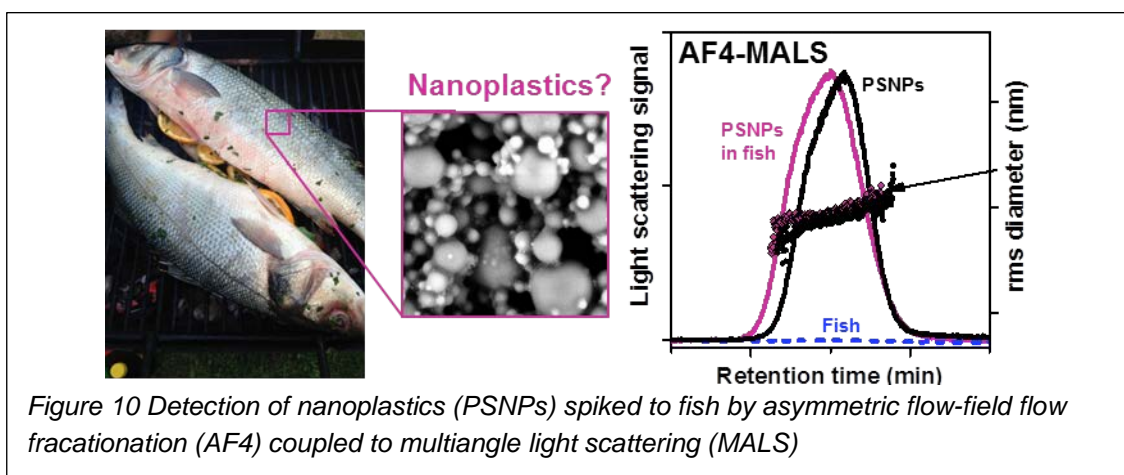

Figure 9 Overview of six open questions (Q1 to Q6) about the migration of engineered nano-objects (ENO) from food contact materials (FCM)

The previous work focused on metal and metal oxide particles. To address the emerging issue of nanoplastics, we performed a study to test whether we are able to analyze nanoplastics (which are polymeric nanoparticles). We tested the suitability of asymmetric flow field flow fractionation (separation method) coupled to multi angle light scattering (detection) for detection of nanoplastics in fish. The results demonstrated that it was possible to use separate 100 nm polystyrene nanoparticles from enzymatically digested fish and to determine their size. However, it was not possible to detect polyethylene nanoparticles in fish. Our results demonstrated that an analytical method developed for a certain type of nanoplastics may not be directly applicable to other types of nanoplastics and may require further adjustment. Despite the current limitations, the developed method is promising for detecting nanoplastics in food see figure. One limitation of the procedure related to identification of the detected nanoplastic particles, as the light scattering signal is not selective to a specific type of nanoparticles. For identification of the eluting nanoplastics, a possibility consists of off-line analysis of the collected size fractions by spectroscopy or spectrometry techniques, like FTIR spectroscopy, Raman spectroscopy or py-GC/MS. A scientific paper with the title “Detection of nanoplastics in food by asymmetric flow field-flow fractionation coupled to multi-angle light scattering: possibilities, challenges and analytical limitations” was published in the international journal Analytical and Bioanalytical Chemistry in January 2018 (Correia, M. and Loeschner, K. Anal. Bioanal. Chem. 2018, 410, 5603-5615).



Microplastics

Fish feed designed to highlight different effect of micro-plastic ingested (clean feed, contaminated feed with and without micro-plastics) was prepared for the experiments. In cooperation with scientist in Spain, this feed was also fed to zebrafish and the toxicity measured by gene expression was studied in liver, brain and intestine. The Salmon samples as well as the feed was analyzed and modeled to understand the mechanism of absorption and elimination from the fat in the fish.

1.4.4 Discussion

Nanoparticles

Labelling for the content of engineered nanomaterials as ingredients in food is mandatory in the European Union since December 2014 in accordance with Regulation 169/2011. Enforcing proper labelling of “nano” poses several analytical challenges. This includes challenges in relation to sample preparation, the limitations of existing analytical techniques and the lack of validated studies and reference materials. A more detailed description regarding the analytical challenges related to nanoparticles in food can be found in our book chapter “Analytical challenges and practical solutions for enforcing labelling of nano ingredients in food products in the European Union” in the book “Nanomaterials for Food Applications” within the Advanced Nanomaterials Series, Elsevier (published 2019). Our studies showed how matrix-specific the methods for nanoparticles are and that it is not possible to develop generic methods. The relatively easy implementation of single particle ICP-MS in state-of-the-art ICP-MS instruments (which can be otherwise used for metal analysis and speciation) makes it a promising technique for routine analysis despite some analytical limitations. In contrast, asymmetric flow field-flow fractionation is not an ideal method for routine analysis of nanoparticles in food. Confirmation of particle size by a secondary method such as electron microscopy is usually required.

Microplastics

The elimination coefficients from salmon fillets were significantly lower for seven of eleven contaminants for a diet with inclusion of 2% 125-200 μm LD-PE microplastic particles with absorbed contaminants compared to a diet without microplastic, but with the same concentrations added to the feed with the oil. The growth corrected accumulations in fillets

appear higher (22±7%) and were in four of eleven contaminants significantly higher for the diet with inclusion of 2% microplastic particles with absorbed contaminants compared to the contaminated diet without micro-plastic, i.e. presence of microplastic particles did not reduce bio-accessibility of contaminants. The results of the sea bass trials fed contaminated diets with or without microplastic have been presented together with the salmon results at an international conference in Brussels. Manuscript of sea bass trial and a revision of the salmon results are in preparation

1.4.5 Conclusions

Nanoparticles

Despite many challenges related to the analysis of nanoparticles in food, it is not an impossible endeavor. DTU Food has built significant expertise in the area and is prepared for upcoming regulations in the area. There are a number of items that are required before suitable analytical methods can be developed in a targeted manner:

- The final definition of a nanomaterial (in context of European Regulation) including a clear definition of the individual parts of the definition (e.g., external dimension).
- Clarity about the implementation of the definition in the food labeling regulation (and other regulations).
- Identification of the existing and most likely expected nanomaterials in food and the food matrices, where they can be expected to be used.

Nanoplastics are polymeric nanoparticles and some of our expertise from metal / metal-oxide based nanoparticles, like titanium dioxide and silver, can be applied. However, additional instrumentation (FTIR spectrometer, py-GC-MS) and further studies would be required to be able to detect nanoplastics in food.

The ability to detect nanoparticles in food is very important, not only in the context of checking proper food labelling, but also for exposure assessment. Further, characterization of nanoparticles in biological samples is a crucial part of risk assessment.

Microplastics

The effect of dietary microplastic exposure on the organ toxicity in zebrafish showed that the liver was most affected; Microplastic alone did not show an effect, however the presence of microplastic in the feed potentiated the effect of chemical contaminants. Microscopic examination showed that the livers of zebrafish exposed to contaminants absorbed to microplastic had rice shaped formations, not found in the samples of either contaminants alone or microplastic alone. These findings will be further supported by chemical analyses of contaminants in the zebrafish livers.

1.5 Overall discussion

As the project have run in quite independent and different sub-topics please see these discussions

1.6 Overall conclusions

The outcome of the three quite different part demonstrate that analytical methodology develops very fast and are becoming far more capable. However, the complexity of the problems of interest also increase with even more complex samples, lower levels and more compounds. To summarize the key out-come are:

- Screening methods for food monitoring, risk mitigation and potential food control.
- New data on occurrence of compounds in food e.g.: Pyrrolizidine alkaloids, mycotoxins.
- An analytic platform to detect metal nanoparticles in food and biological samples, including size distribution
- Data on occurrence and fate of nano-particle
- Effect of micro plastics in the food chain (fish) as a transport of environmental contaminants.
- An assessment of the possibility to build a sensor system for food test
- 1 PhD thesis and 3 pending PhD thesis
- 4 well educated PhD candidates for industry, public sector or academia.

Furthermore, DTU have over the course of the project evolved the analytical competences and developed the analytic platform significantly to be ready for the future challenges.

1.7 Perspectives

During this 4-year program screenings methods are slowly becoming the standard in food analysis. The Asterix program in Fødevareforlig 3 has given Denmark a head start using these screening methods. During the development of these screenings method valuable data was acquired for urgent food monitoring including data on PA compounds in honey and several plants derived materials.

While the part on development of sensors techniques did not meet expectations, it did reveal a potential for new analytic technologies. In general microelectronics and manufacturing techniques have advanced significantly during this 4-year program, and if started today would probably take another route.

The work on nano particles and micro plastics have establish analytic platforms for further studies as already in progress in an EU project.

Dissemination

Four PhD thesis

15-20 scientific papers (marked in bold under references)

Several popular presentations

New methods and knowledge available for Danish authorities.

References

“A framework to estimate concentrations of potentially unknown substances by semi-quantification in liquid chromatography electrospray ionization mass spectrometry” Pieke, Eelco Nicolaas; Granby, Kit; Trier, Xenia; Smedsgaard, Jørn; in journal: *Analytica Chimica Acta*, 975, pp 30-41, 2017a.

“Exploring the chemistry of complex samples by tentative identification and semi-quantification: a food contact material case”; Pieke, Eelco Nicolaas ; Smedsgaard, Jørn ; Granby, Kit : *Journal of Mass Spectrometry* 2017b, (ISSN: 1076-5174) (DOI: <http://dx.doi.org/10.1002/jms.4052>). This paper captured the attention by Chemwatch see: <https://chemicalwatch.com/55957/danish-team-estimates-levels-of-unknown-chemicals-in-complex-mixtures>.

“Prioritization before risk assessment: The viability of uncertain data on food contact materials” Pieke, EN., Granby, K., Teste, B., Smedsgaard, J., Rivière; G., 2018. *Regulatory Toxicology and Pharmacology* 97, 134–143

“Identification and risk prioritization of unknown contaminants migrating from paper and board food contact materials” Pieke, Eelco Nicolaas, Ph.D. Thesis Technical University of Denmark, National Food Institute, Lyngby Denmark, May 2018, 169 pp., ISBN 978-87-93565-17-3.

“Strategy to determine response factors for “unknowns” and NIAS in paper and board by LC-ESI-MS” Pieke, Eelco Nicolaas 2015. Oral presentation at Conference: Extractables and Leachables in packaging materials, arranged by Waters Corp., Copenhagen Denmark, 5 May 2015

“Chemicals in paper and board food contact material: towards more knowledge, analytical and prioritization analysis” Pieke EN, Granby K, Boriani E. 2016. Poster at 6th International Symposium on Food Packaging – Scientific Developments Supporting Safety and Innovation. ILSI Europe Packaging Materials Task Force, 16-18 November 2016

“Bridging the gap between food packaging safety and the world of unknown chemicals” Pieke, E. 2017. Oral presentation at GoFood 2017: The 2nd Global Food Safety & Technology Forum, Lund, Sweden; Copenhagen Denmark, 31 May–2 June 2017, organized by Joint Centre of Excellence in Food Safety.

“Food contact paper & board chemicals: setting priority based on screening methodology” Pieke, E. 2017, Keynote speaker at Food Contact Material Safety Symposium (FCS), Xi’an, China 2–3 November 2017.

“How does chemical exploration aid in the risk assessment of NIAS in FCM?” Pieke, E. 2017, Keynote speaker at conference Challenges and Management of Non-intentionally Added Substances (NIAS) Beijing, China 5 November 2017 organised by ILSI Focal Point China; China National Centre for Food Safety Risk Assessment (CFSA).

“Fighting unknown chemicals: analytical strategies for risk Prioritization”. Pieke, E. 2017, Oral presentation at Joint International Symposium: Global Past, Present and Future Challenges in Risk Assessment – Strengthening Consumer Health Protection, German Federal Institute for risk assessment (BfR), Berlin, Germany, 31 November–1 December 2017.

“Burden of disease of exposure to endocrine-disrupting chemicals in recycled paper used for food packaging in Denmark: a case-study” Elena Boriani, Eelco Pieke, Tine Hald, Sara Pires, Julie Boberg, Lea Sletting Jakobsen. Poster at Joint International Symposium: Global Past, Present and Future Challenges in Risk Assessment – Strengthening Consumer Health Protection, German Federal Institute for risk assessment (BfR), Berlin, Germany, 31 November–1 December 2017.

UHPLC-MS/MS determination of Ochratoxin A and Fumonisin in Coffee using QuEChERS extraction combined with Mixed-mode SPE purification. Kristian F. Nielsen, A. F. Ngemela, L. B. Jensen, L.S. Medeiros, P. Have Rasmussen. *Journal of Agricultural and Food Chemistry* 63: 1029-1034 (2015).

Enniatin B and beauvericin are common in Danish cereals and show high hepatotoxicity on a high-content imaging platform. T. Svingen, N.L. Hansen N., C. Taxvig, A.N. Vinggaard, U. Jensen, P.H. Rasmussen. *Environmental Toxicology* 32: 1658-1664 (2017).

Extensive literature search for studies related to fumonisins and their modified forms. Elsa Nielsen, Mikael Mandrup Egebjerg, Pelle Thonning Olesen, Anoop Kumar Sharma, Karin Nørby, Vibe Beltøft, Peter Have Rasmussen, Lea Bredsdorff, Max Hansen, Folmer Eriksen, Kirsten Pilegaard, Gitte Ravn-Haren, Kevin Jørgensen. EFSA Report, Volume 15, issue 2: 175 pages (2018).

Chemical Contaminants, Food monitoring 2012-2013. Annette Petersen, Arvid Fromberg, Jens Hinge Andersen, Jens J. Sloth, Kit Granby, Lene Duedahl-Olesen, Peter Have Rasmussen, Tommy Licht Cederberg (DTU Food, National Food Institute, 2016).

‘Mycotoxins and pesticides in food and feed from cereals: status and new challenges. Oral presentation (invited), Foss Analytical A/S, Hillerød, 21. June 2018.

“The influence of microplastic inclusion in feed on carryover of marine pollutants from feed to seabass and salmon”. Granby Kit, Rie Romme Rasmussen, Michiel Kotterman, Jens-Jørgen Sloth, Tommy Licht Cederberg, Antonio Marques, Albert A. Koelmans, Bodil Katrine Larsen. Oral presentation, Seafood Safety: New Findings & Innovation Challenges, Royal Flemish Academy of Belgium for Science and the Arts, Brussels, Belgium, 25–26 January 2017

“Carryover of methylmercury from feed to seabass and salmon”. Rasmussen Rie Romme, Bodil Katrine Larsen, Michiel Kotterman Jens-Jørgen Sloth, Antonio Marques, Kit Granby Poster presentation, Seafood Safety: New Findings & Innovation Challenges, Royal Flemish Academy of Belgium for Science and the Arts, Brussels, Belgium, 25–26 January 2017.

“Toxicity of emerging chemical contaminants evaluated in vivo with classic and alternative approaches using the zebrafish animal model” Rainieri Sandra; Nadia Conlledo; Bodil K Larsen; Kit Granby; Alejandro Barranco. Oral presentation, Seafood Safety: New Findings & Innovation Challenges, Royal Flemish Academy of Belgium for Science and the Arts, Brussels, Belgium, 25–26 January 2017

Effects of dietary micro-plastic exposure on the organ toxicity of a mixture of chemical contaminants in zebrafish (Danio rerio), Rainieri, S.; Conlledo, N.; Larsen, BK; Granby, K; Barranco, A.; *Toxicology Letters*, Vol. 258, No. Supplement, P19-010, 2016, p. 285-286. doi.org/10.1016/j.toxlet.2016.06.1995

“Combined effects of microplastics and chemical contaminants on the organ toxicity of zebrafish (Danio rerio)”. Rainieri, S.; Conlledo, N.; Larsen, BK; Granby, K; Barranco, A 2018. . *Environmental Research* 162, 135-143.

The influence of microplastic inclusion in feed on the toxicokinetics of brominated flame retardant and PCBs in Atlantic salmon (Salmo salar); Kit Granby; Rie R Rasmussen; Michiel J Kotterman; Jens-Jørgen Sloth; Tommy L Cederberg; Antonio Marques; Albert A Koelmans; Bodil K Larsen (revision in prep.)

The influence of microplastics and halogenated contaminants in feed on toxicokinetics and gene expression in European seabass (Dicentrarchus labrax). Granby Kit, Sandra Ranieri, Rasmussen Rie Romme; Michiel Kotterman ; Jens-Jørgen Sloth , Tommy Licht Cederberg , Alex Barranco, António Marques , Bodil Katrine Larsen. 2018. *Environ. Research*, 164, 430-443.

Recycling of plastic waste: Screening for brominated flame retardants (BFRs), Pivnenko K, K. Granby, E. Eriksson, T.F. Astrup. 2017 *Waste Management* 69, 101-109.

Plastics and effect on male reproduction. 2018 Boberg J., Granby K., Svingen T. Vinggaard AM. *Environmental Toxicology: Plastics*, Encyclopedia of Reproduction, Skinner, M. (ed.). 2 ed. Academic Press, 5 p. reference module in biomedical sciences. DOI 10.1016/B978-0-12-801238-3.64382-9.

“Studies on combinations of microplastics and persistent organic contaminants in fish.” Granby, Kit. Præsentation ved Strategidag mellem DTU og Miljøstyrelsen/Fødevarestyrelsen. DTU, 14 September 2018.

“Effects of perfluorinated substances in combinations with/without microplastics in feed on their toxicokinetic behaviour in fish”. M.Sc. report Ninna Johannsen, Technical University of Denmark 100pp, 1 March 2019.

Wang, T, Frandsen, HL, Roed Christiansson, N, Rosendal, SE, Pedersen, M & Smedsgaard, J 2019, *'Pyrrolizidine alkaloids in honey: Quantification with and without standards'* *Food Control*, vol 98, pp. 227-237. DOI: 10.1016/j.foodcont.2018.11.033

“An effect-directed strategy for characterizing emerging chemicals in food contact materials made from paper and board.” Rosenmai, Anna Kjerstine; Bengtström, Linda; Taxvig, Camilla; Trier, Xenia; Petersen, Jens Højslev; Svingen, Terje; Binderup, Mona-Lise; van Vugt-Lussenburg, Barbare Medea Akuce; Dybdahl, Marianne; Granby, Kit; Vinggaard, Anne Marie. *Food and Chemical Toxicology*, Vol. 106, No. Part A, 2017, p. 250-259.

“Non-targeted screening for contaminants in paper and board food-contact materials using effect-directed analysis and accurate mass spectrometry.” Bengtström, Linda; Rosenmai, Anna Kjerstine; Trier, Xenia; Jensen, Lisbeth Krüger; Granby, Kit; Vinggaard, Anne Marie; Driffield, Malcolm; Petersen, Jens Højslev. *Food Additives & Contaminants: Part A - Chemistry, Analysis, Control, Exposure & Risk Assessment*, Vol. 33, No. 6, 2016, p. 1080-1093.

“High Resolution Mass Spectrometry of Polyfluorinated Polyether-Based Formulation” Dimzon, Ian Ken, Xenia Trier, Tobias Frömel, Rick Helmus, Thomas P. Knepper, Pim de Voogt, 2016 *J. Am. Soc. Mass Spectrom.* 27:309-318

“The Madrid statement on poly- and perfluoroalkyl substances (PFASs)” Blum A, Balan SA, Scheringer M, Goldenman G, Trier X, Cousins I et al.. 2015. *Environ Health Perspect* 123(5):A107-A111; doi:10.1289/ehp.150991025932614.

National Food Institute
Technical University of Denmark
Building 202
Kemitorvet
2800 Lyngby

Tel: +45 35 88 77 00

ISBN: 978-87-93565-64-7

www.food.dtu.dk